

TYP_C

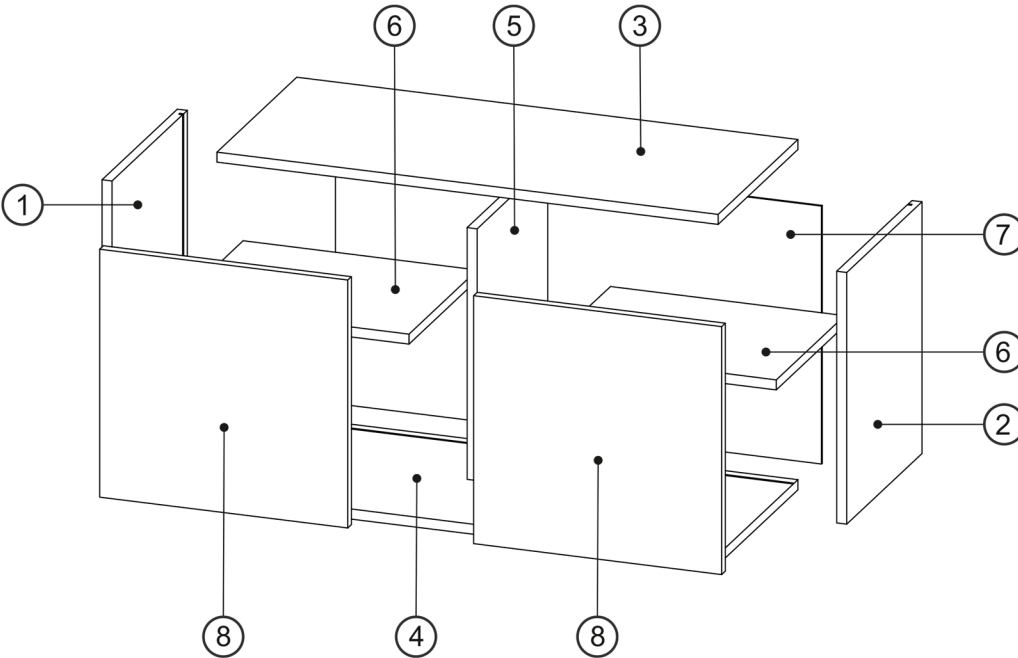

①	402	330	16 x1	1/1
②	402	330	16 x1	1/1
③	800	350	16 x1	1/1
④	800	350	16 x1	1/1
⑤	402	310	16 x1	1/1
⑥	374	300	16 x2	1/1
⑦	776	412	3 x1	1/1
⑧	396	396	16 x2	1/1
				1/1

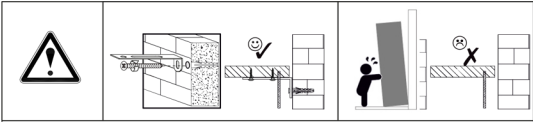
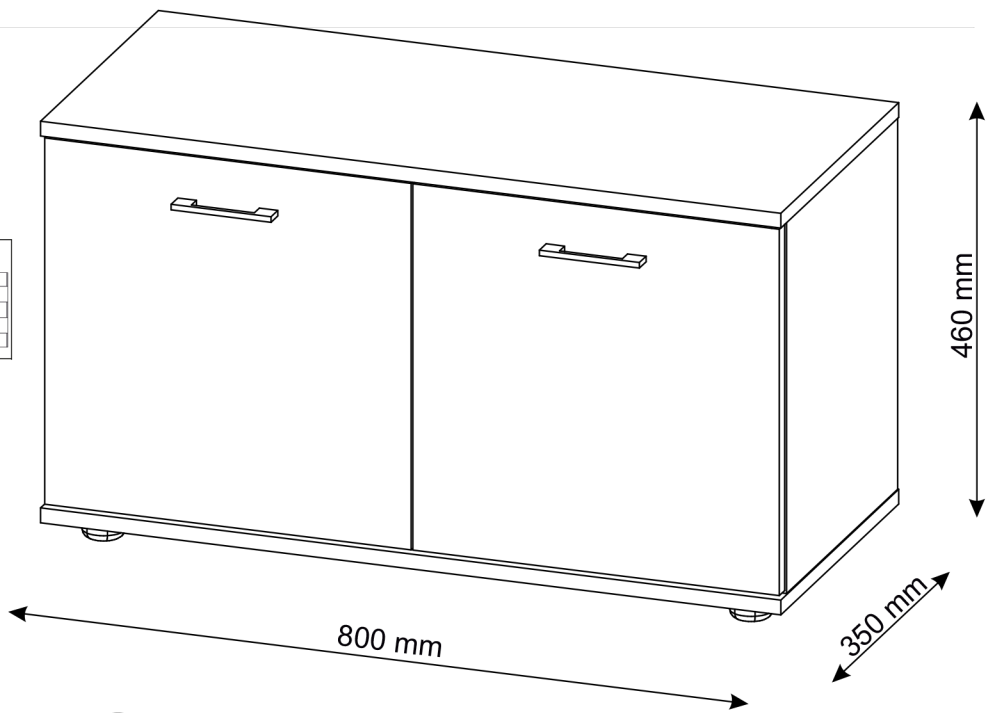
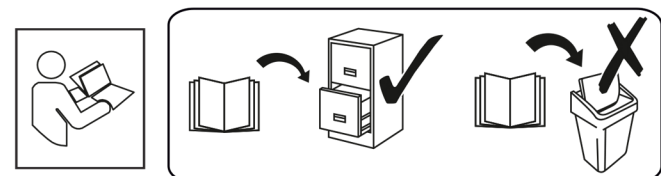
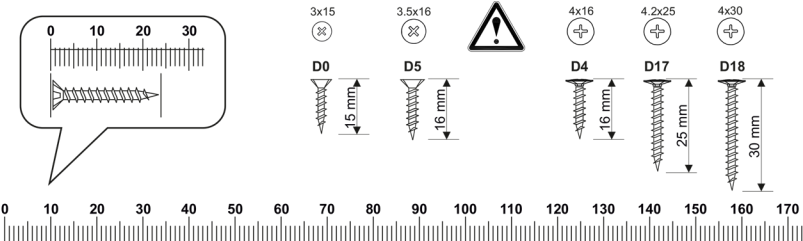

A0 Ø8x30 x12	B1 Ø7x50 x6	C0 x6	C2 x6	C7 16 mm x6	D0 3x15 x8	D5 3.5x16 x10	D4 3.5x16 x2	D17 4.2x25 x4	D18 4x30 x4	E0 8x50 x1
---------------------------	--------------------------	-----------------	-----------------	--------------------------	-------------------------	----------------------------	---------------------------	----------------------------	--------------------------	-------------------------

J17 x4	K 4mm x1	L13 x2	M1 x8	P0 x1	Q0 x8	T12 x4	U0 x4
------------------	-----------------------	------------------	-----------------	-----------------	-----------------	------------------	-----------------

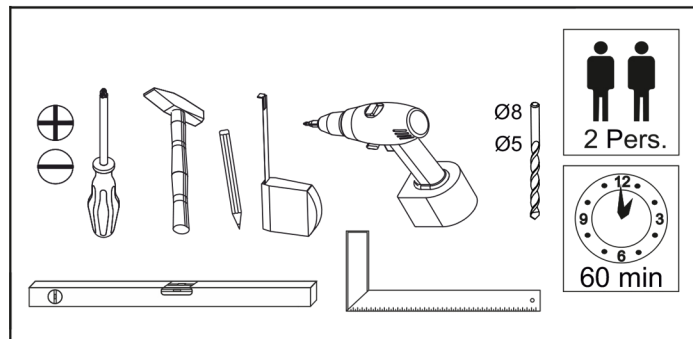

1

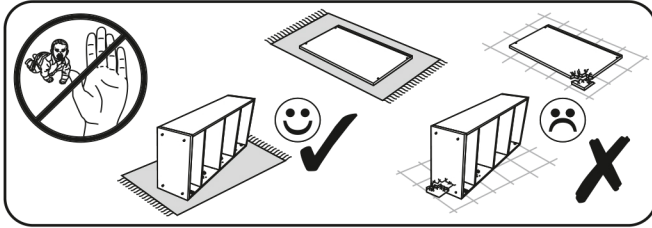

A0 Ø8x30 x4	C2 x6	C7 16 mm x2	D17 4.2x25 x4	T12 x4
-------------------------------------	----------------------------	-------------------------------------	---------------------------------------	-----------------------------

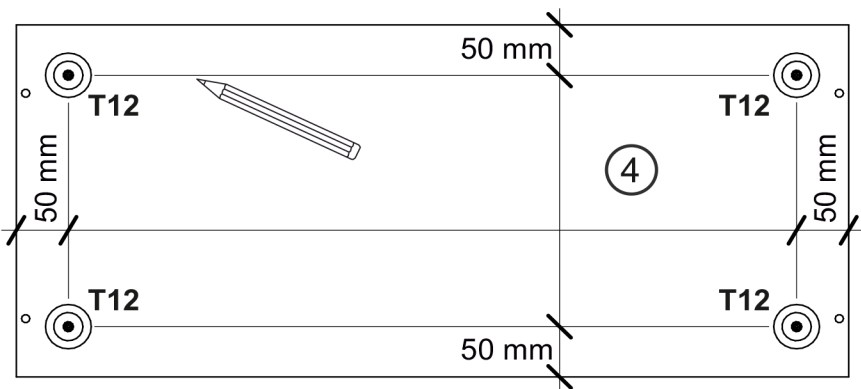
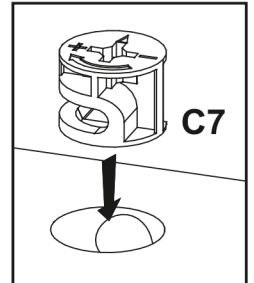
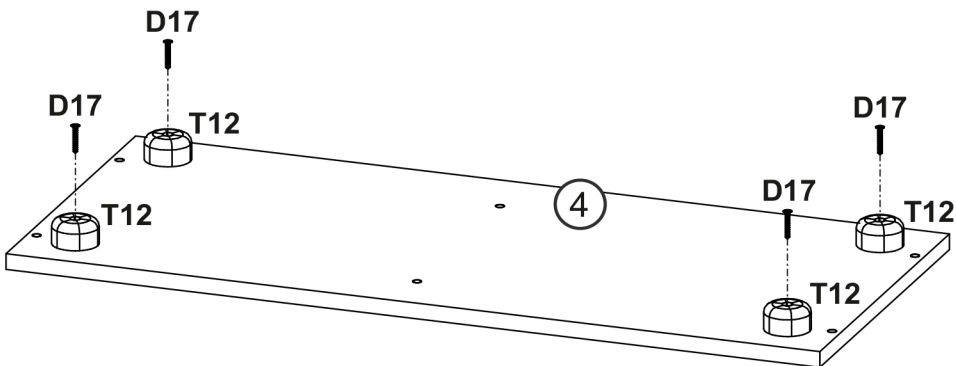
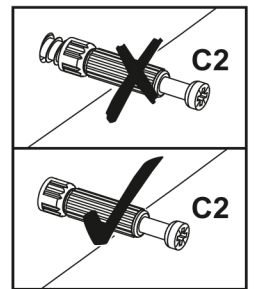
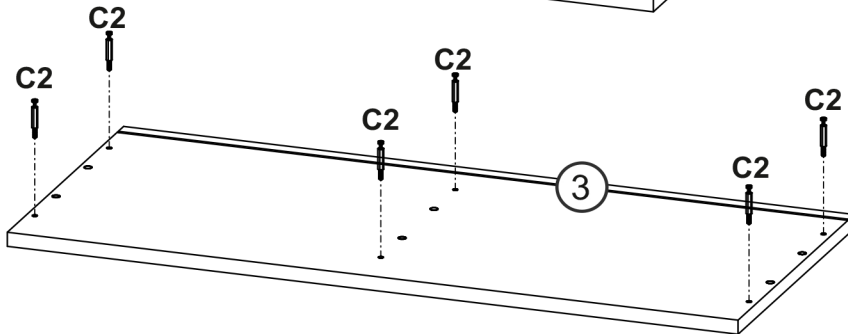
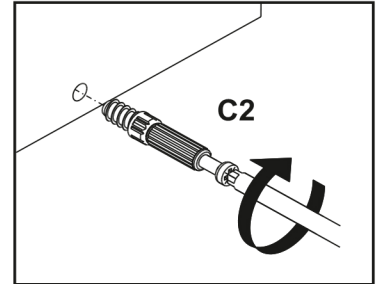
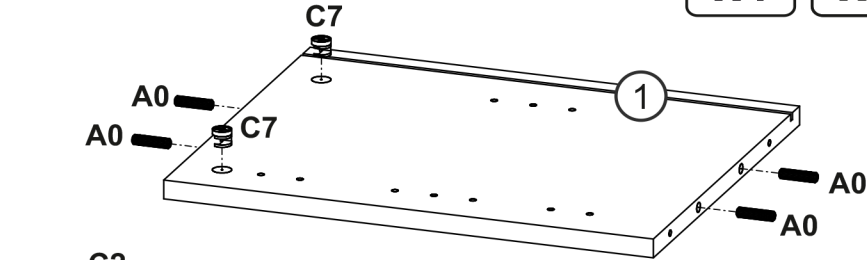

4.2x25



D17

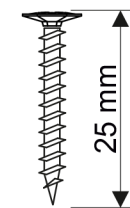

4x30



D18

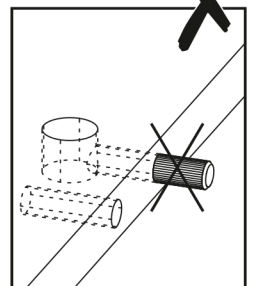
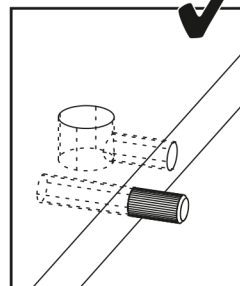
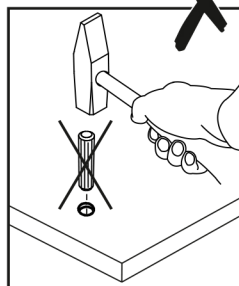
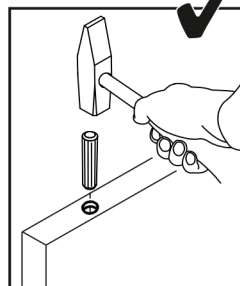
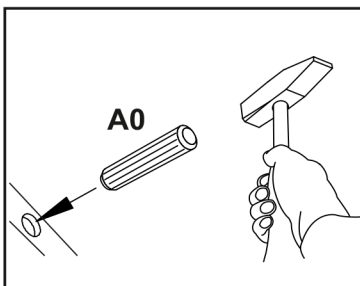
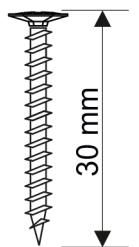

2

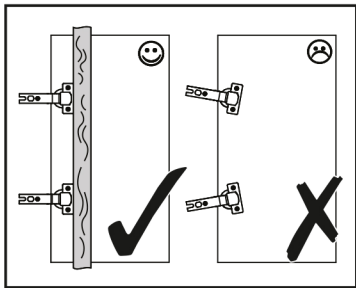

A0 Ø8x30 x8	C7 16 mm x4	D5 3.5x16 x8	J17 x4
-------------------------------------	-------------------------------------	--------------------------------------	-----------------------------

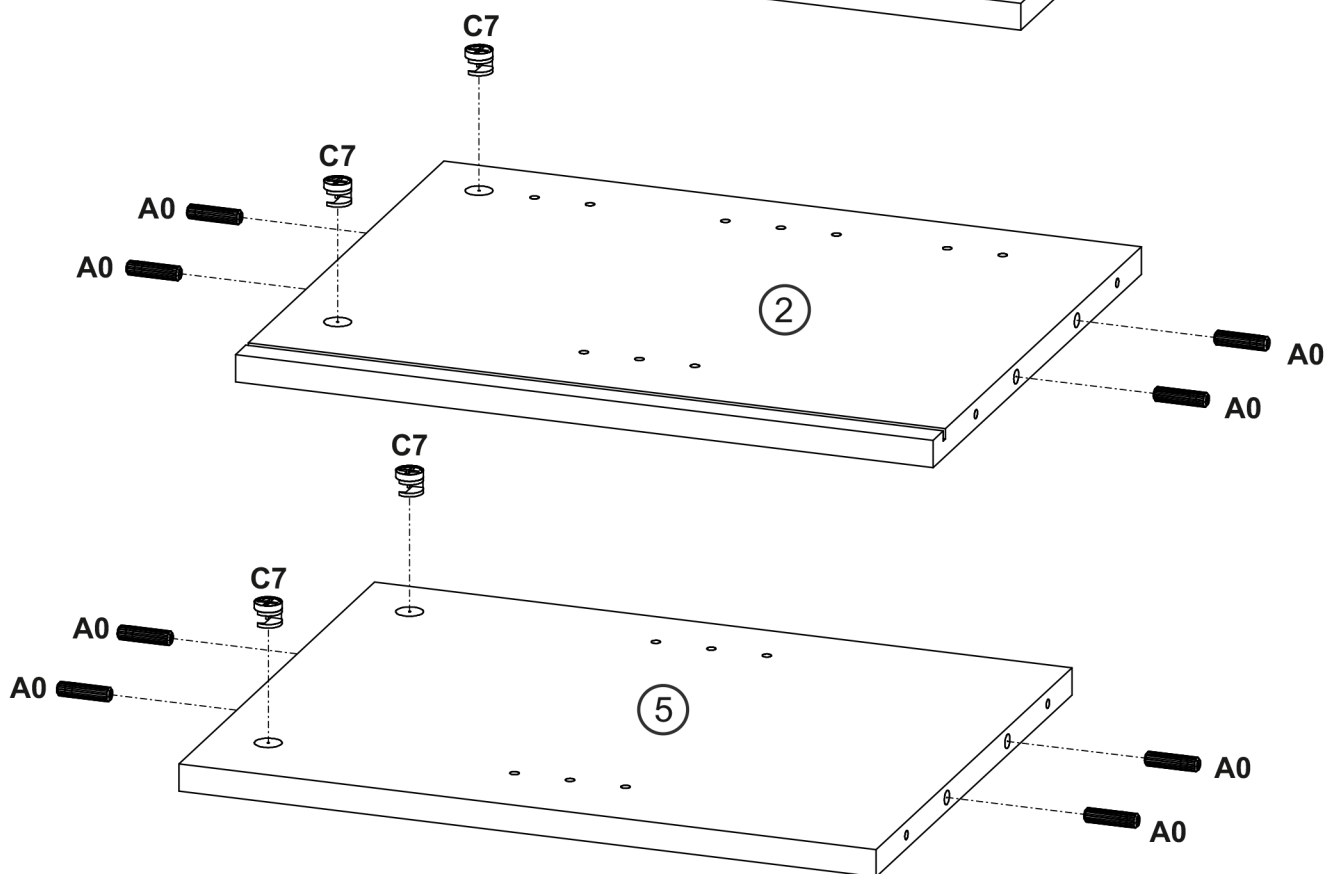
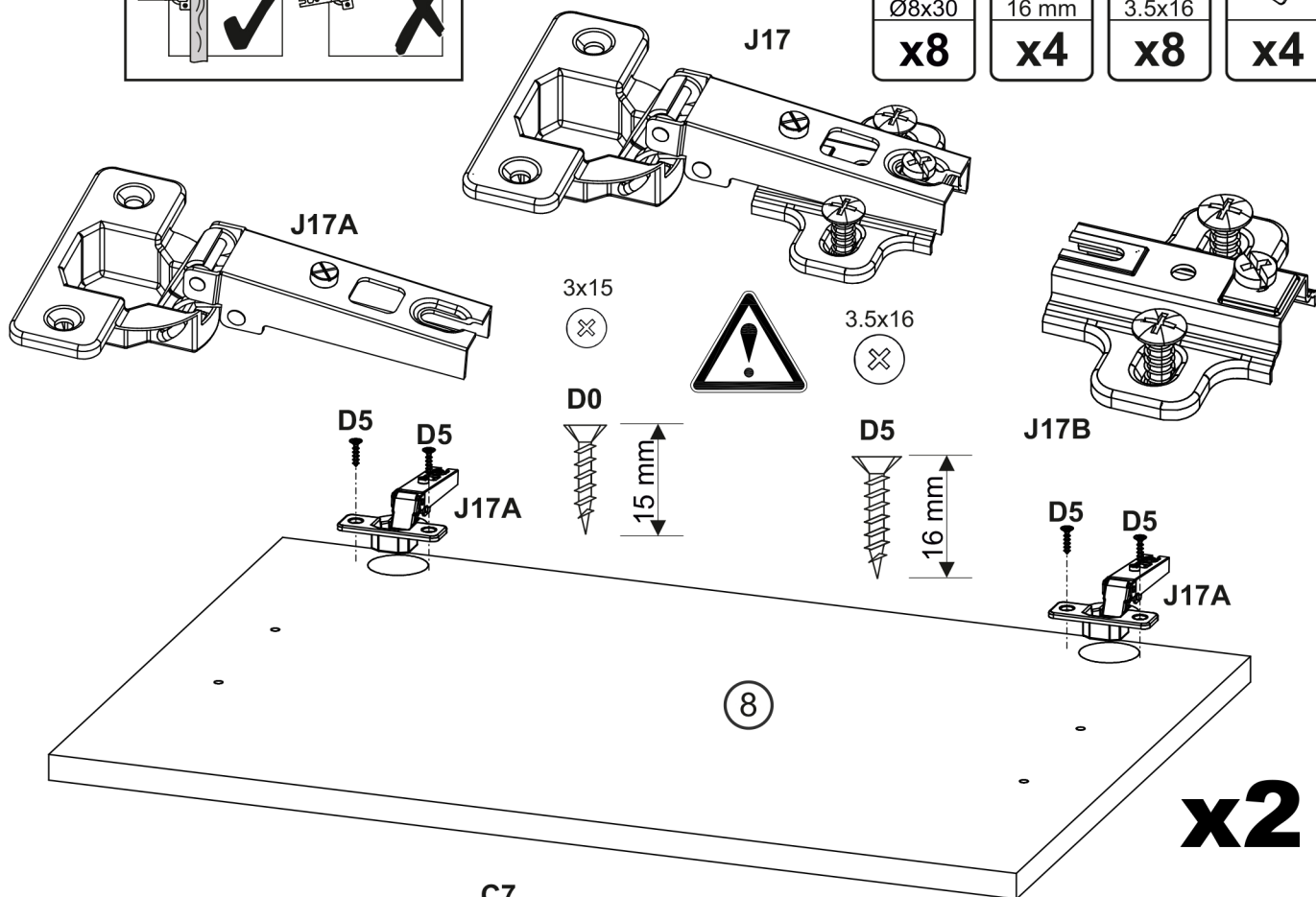

3

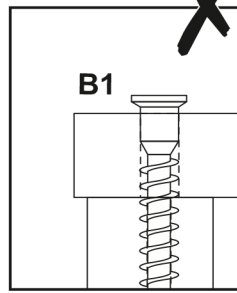
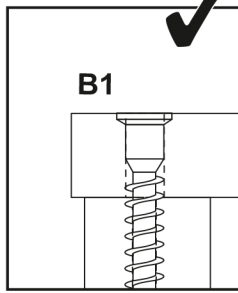
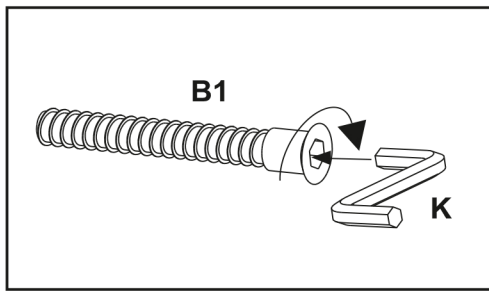

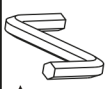
B1	K
	
Ø7x50	4mm
x6	x1

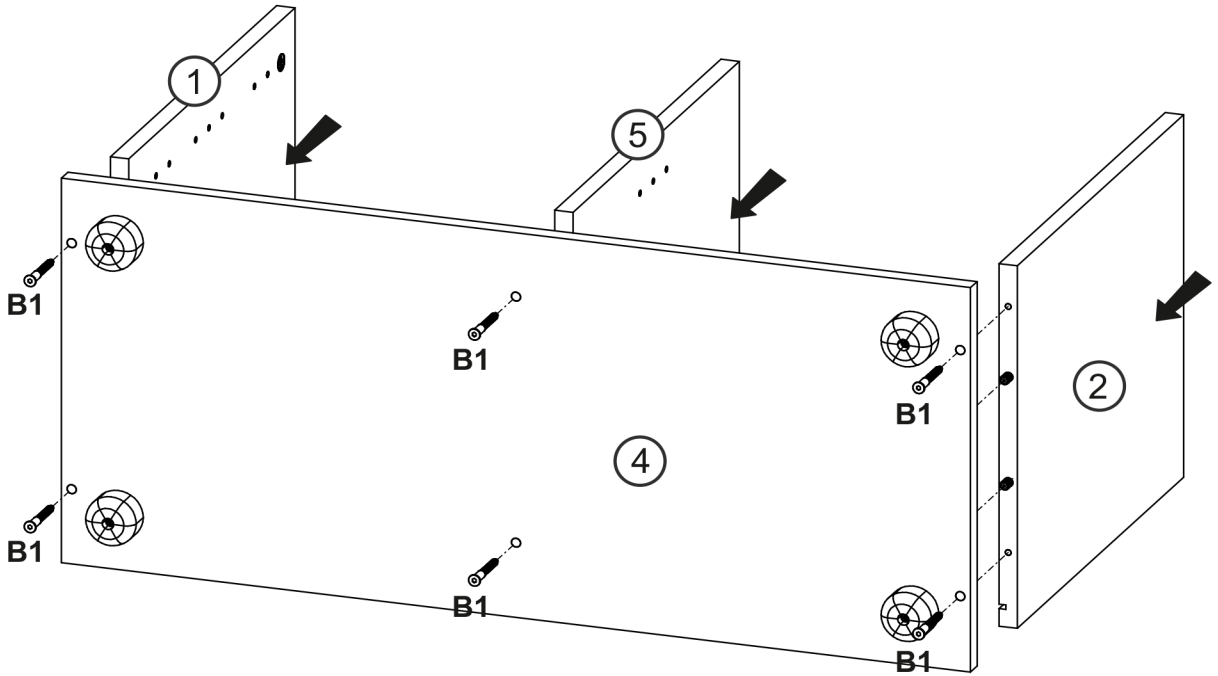

4

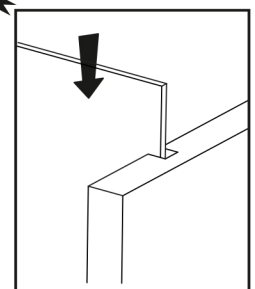
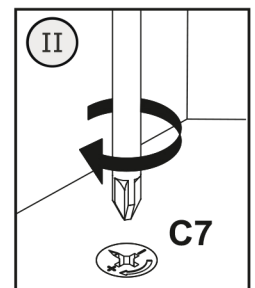
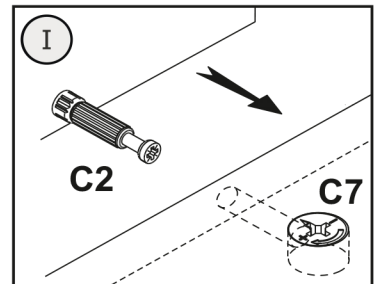
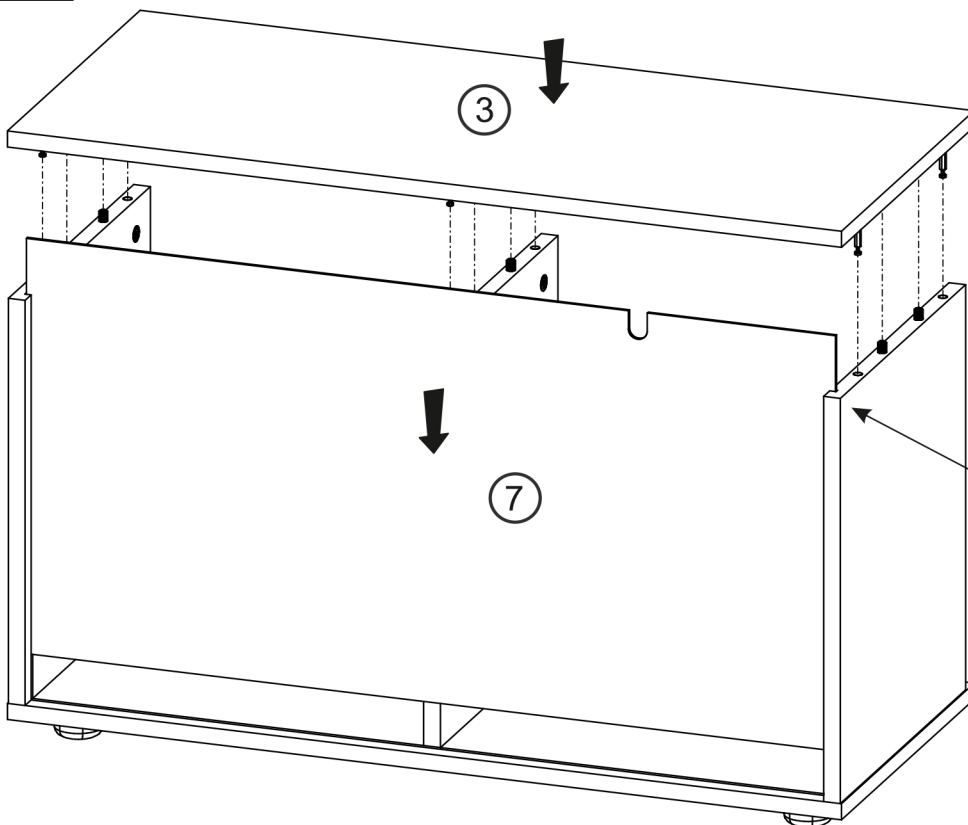

5

3x15



3.5x16



4x16



D0



3x15

x8

D4



3.5x16

x2

M1



x8

D0

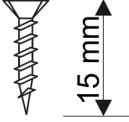

D5

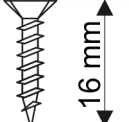

D4

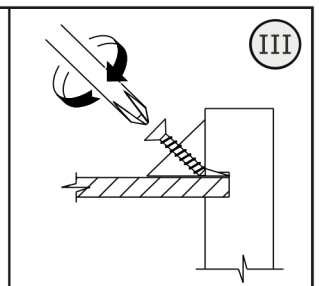
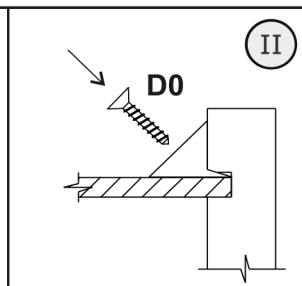
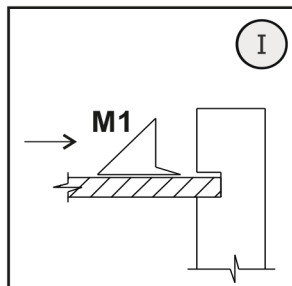
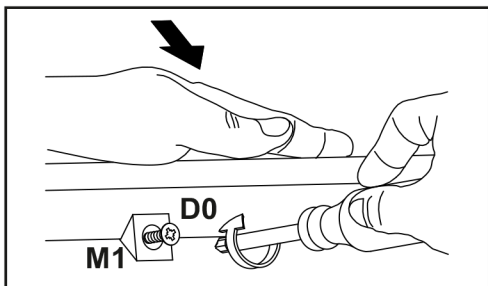
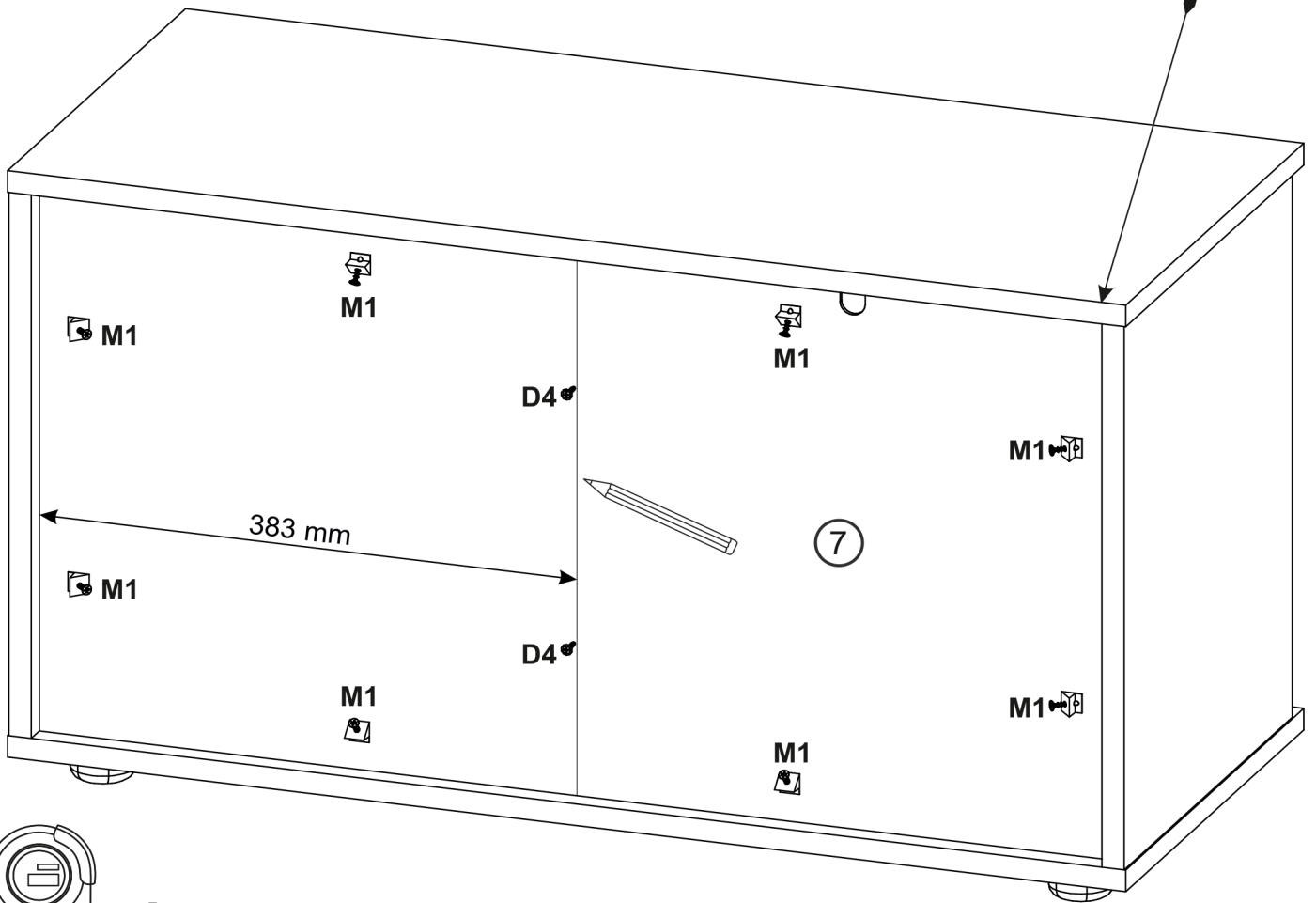
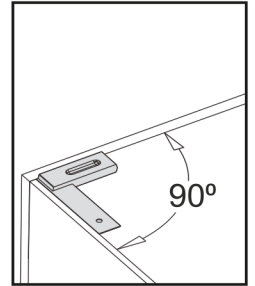
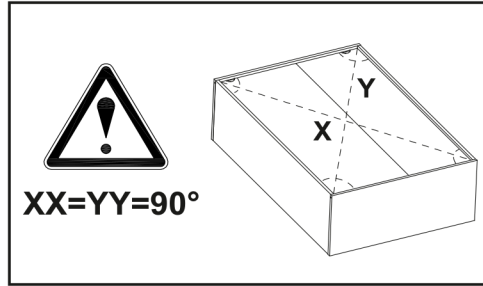
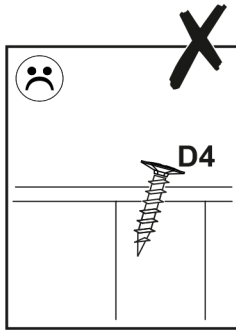
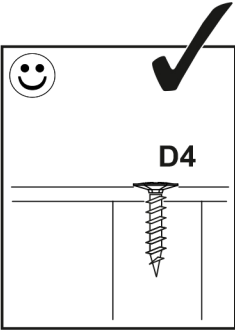
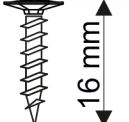

6

3x15



3.5x16



4x16



D0

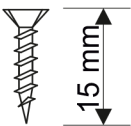

D5

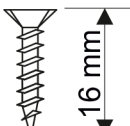

D4

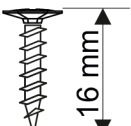

D5	E0	P0
3.5x16	8x50	
x2	x1	x1

I

II

III

Ø 8mm

IV

V

VI

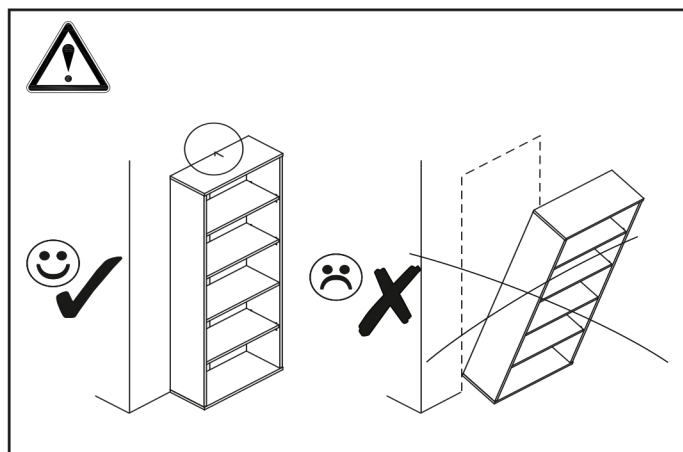
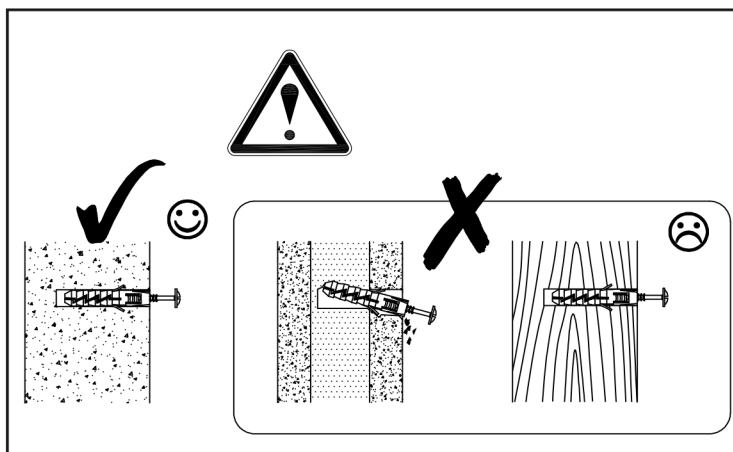
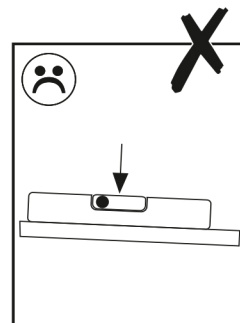
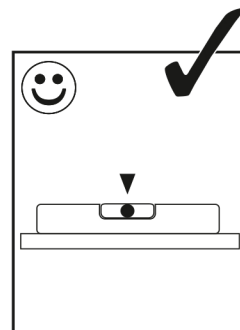
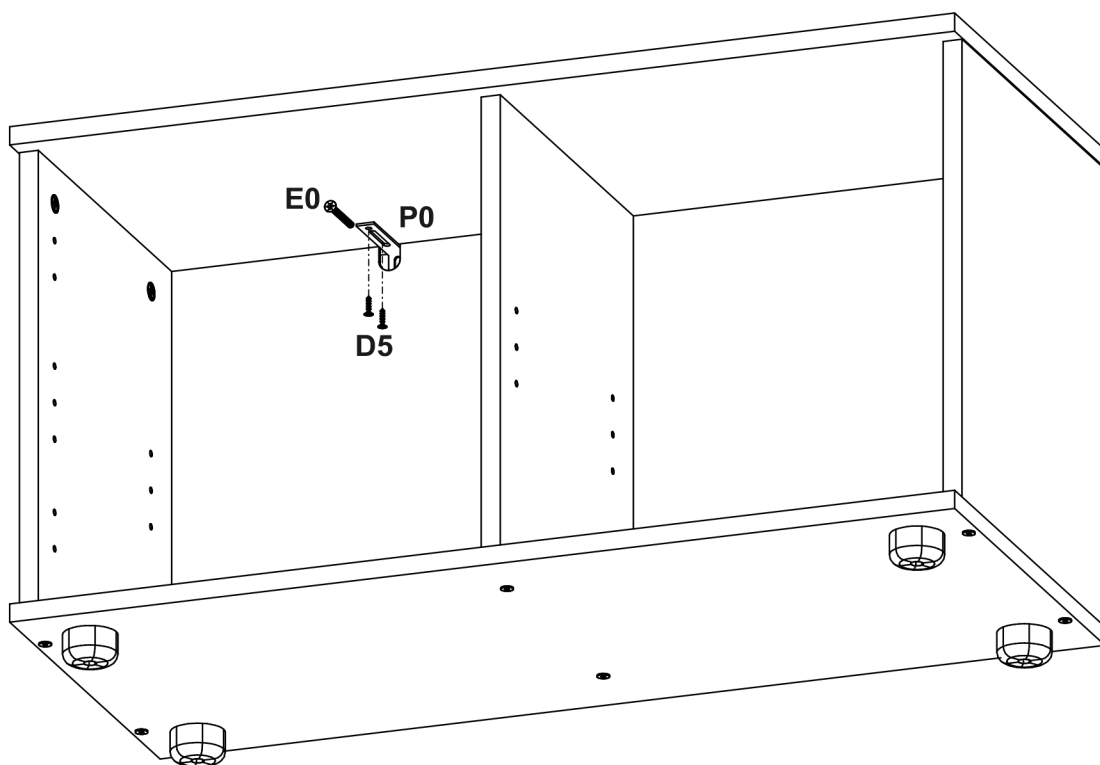

7

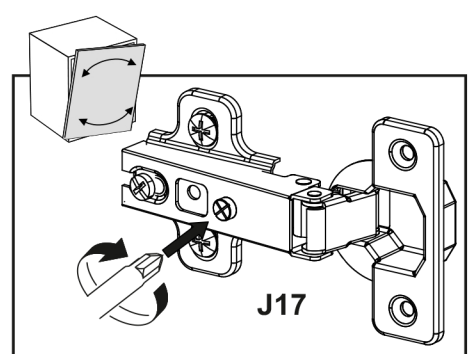
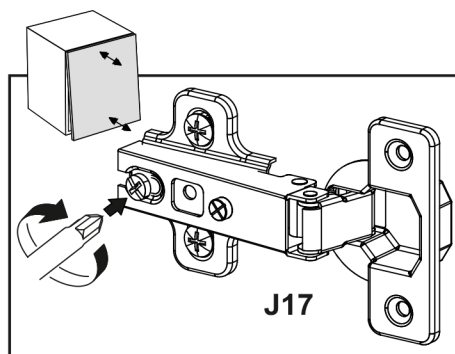
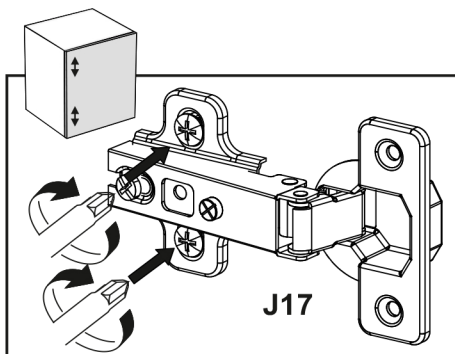
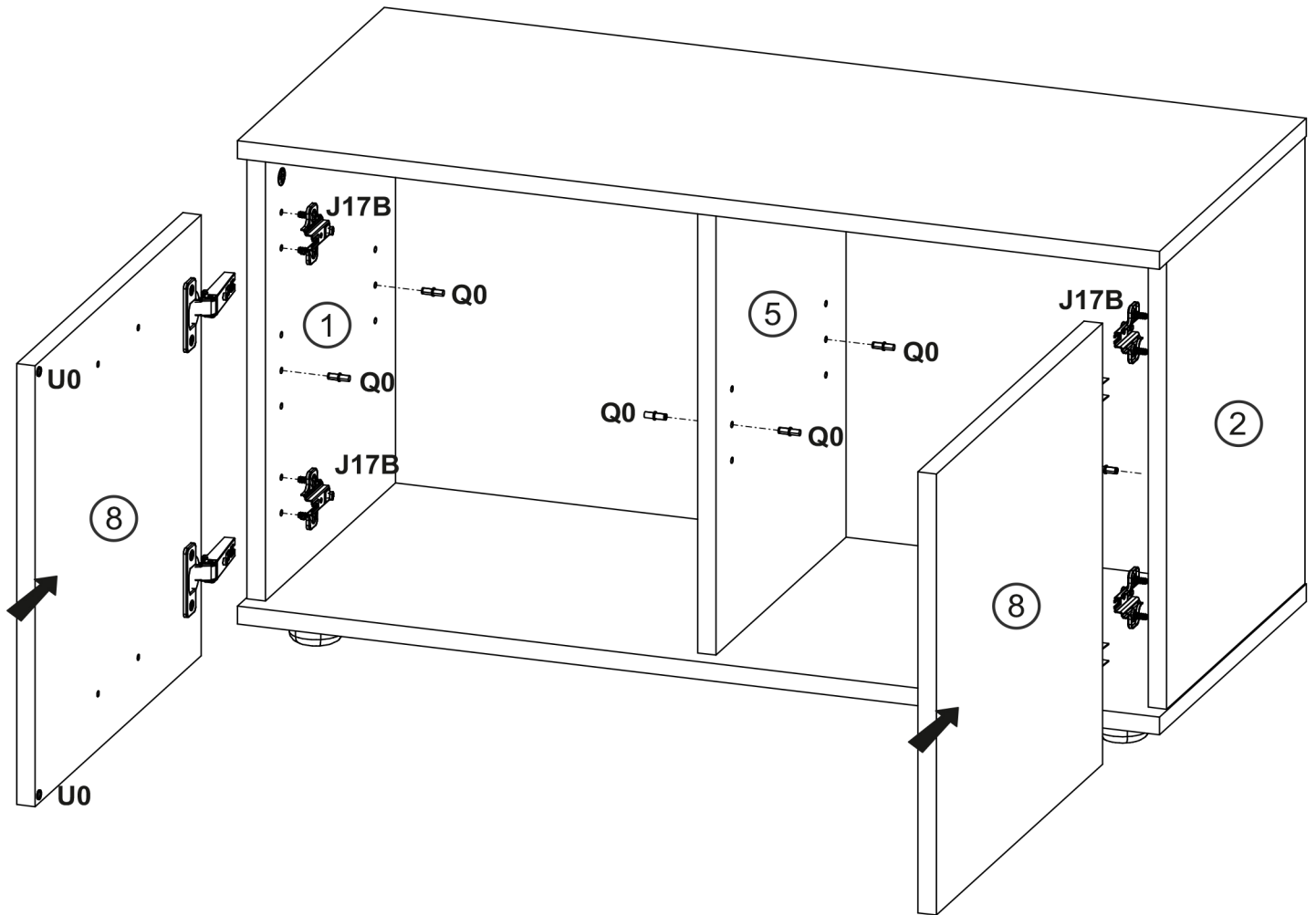
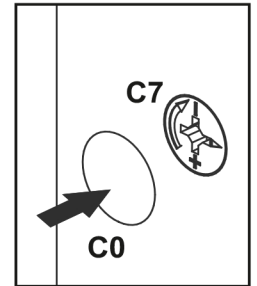
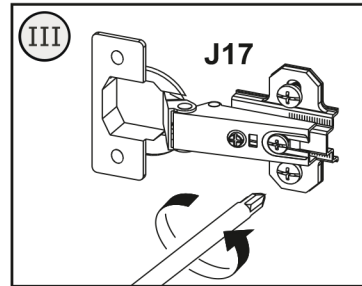
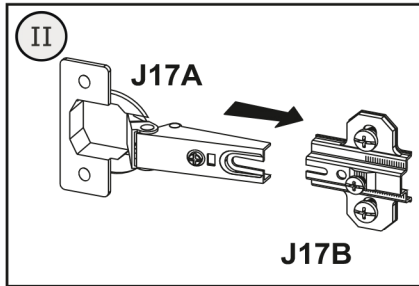
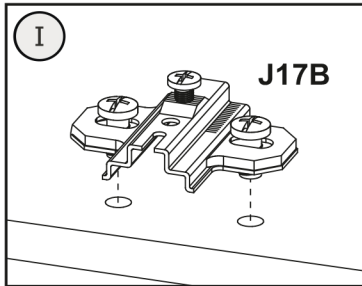
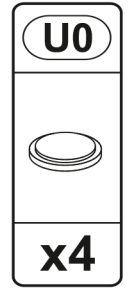
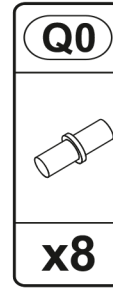
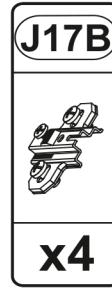
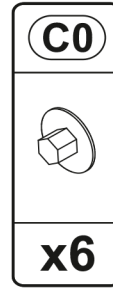
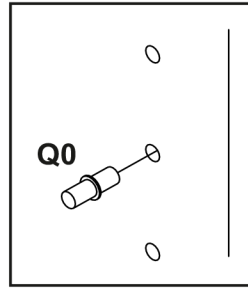
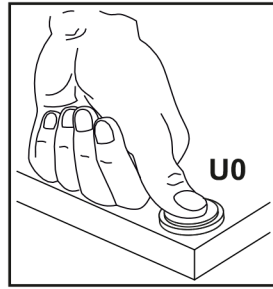
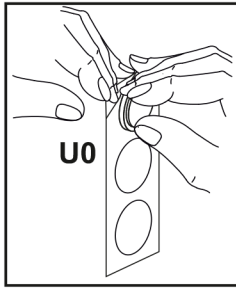

8

4.2x25



D17

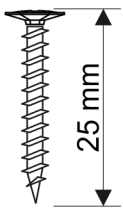

4x30



D18

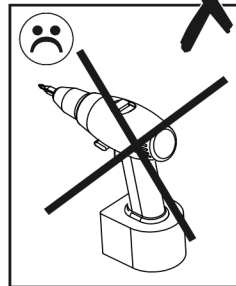
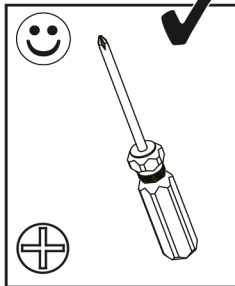
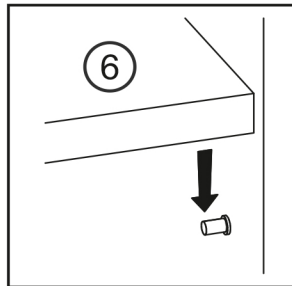
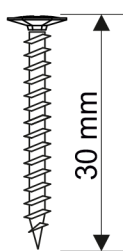

D18



x4

L13

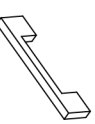

x2

